

# WING KITCHEN

Parisotto+Formenton



## COLORS AND MATERIALS COLORI E MATERIALI - COULEURS ET MATÉRIAUX

TOP  
PIANO  
PLATEAU

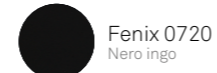
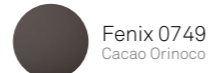
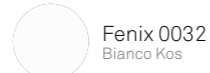

STRUCTURE AND LEGS  
STRUTTURA E GAMBE  
STRUCTURE ET PIEDS

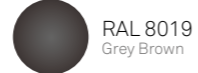

The standard finishings for the steel bases are the RAL shown above. Customized RAL colors are available upon request.

Le finiture standard delle basi in acciaio sono i RAL qui mostrati. Su richiesta sono disponibili colorazioni customizzate su altre tinte RAL.

Les finitions standard pour les socles en acier sont les RAL indiquées ci-dessus. Des finitions de couleurs RAL personnalisées sont disponibles sur demande.

TOP AND DRAWER  
PIANO E CASSETTI - PLATEAU ET TIROIRS

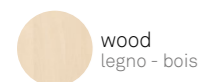

LEGS AND BEAM  
GAMBE E TRAVE - PIEDS ET POUTRE

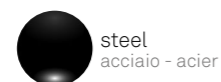

## TECHNICAL FEATURES SPECIFICHE TECNICHE - SPÉCIFICATIONS TECHNIQUES

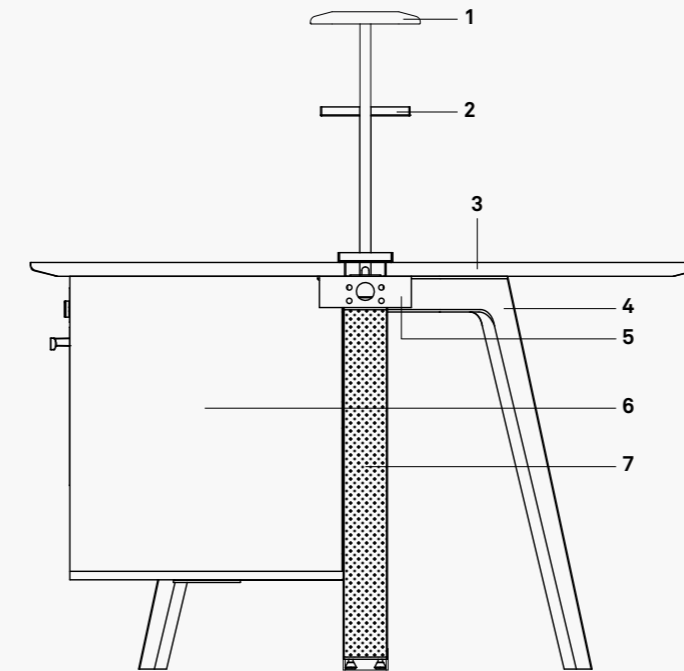

### 1. Led lamp with lacquered MDF structure

Lampada a led con struttura in MDF laccato  
Lampe à LED avec structure en MDF laqué

### 2. Steel trays

Vassoi in acciaio  
Plateaux en acier

### 3. Birch plywood top with Fenix veneer

Piano in multistrato di betulla impiallacciato fenix  
Plateau en contreplaqué de bouleau avec placage Fenix

### 4. Steel legs

Gambe in acciaio  
Pieds en acier

### 5. Steel beam

Trave in acciaio  
Poutre en acier

### 6. Aluminum drawer with MDF front

Cassetto in alluminio con frontale in MDF  
Tiroir en aluminium avec façade en MDF

### 7. Supporting column in perforated steel

Colonna portante in acciaio traforato  
Colonne porteuse en acier perforé

Top in marine plywood Fenix® laminated, storage volumes in aluminum with lacquered MDF front. Frame, legs, beam and cable-guide columns in varnished steel.

Piano in multistrato marino Fenix® laminato, volumi di contenimento in alluminio con frontale in MDF laccato. Telaio, gambe, trave e colonne portacavi in acciaio verniciato.

Plateau en contreplaqué marin Fenix® laminé, volumes de rangement en aluminium avec façade MDF laquée. Cadre, pieds, poutres et colonnes de câbles en acier peint.

## RAISED FLOOR PAVIMENTO RIALZATO - FAUX PLANCHER

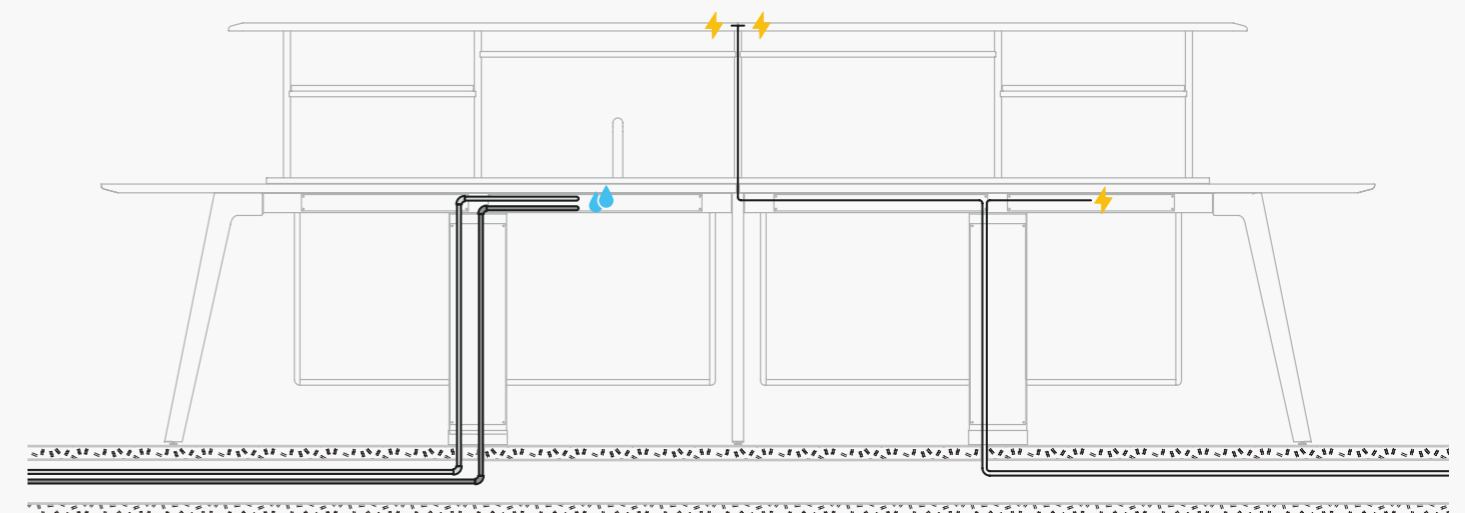

## WING KITCHEN

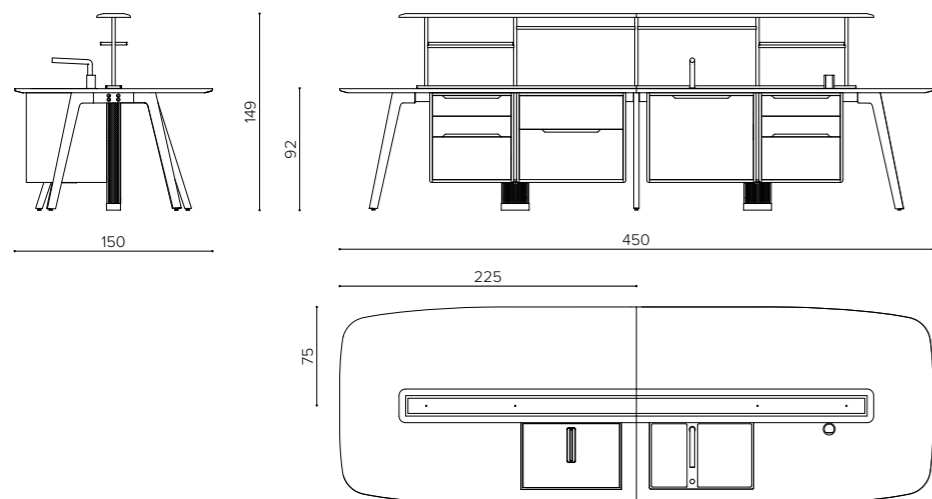

**WI 450K**  
Wing kitchen 450x150 standard configuration  
Wing Kitchen 450x150 configurazione standard  
Wing Kitchen 450x150 configuration standard

## OPTIONAL EQUIPMENT EQUIPAGGIAMENTO OPZIONALE - ÉQUIPEMENT OPTIONEL

**WK**  
V-ZUG combined steam oven  
Forno a vapore combinato V-ZUG  
Four mixte à vapeur V-ZUG

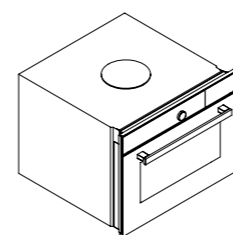

60 W x 60 D x 45 H

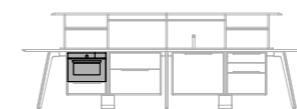

**WK**  
vacuum drawer  
cassetto sottovuoto  
tiroirs à vide

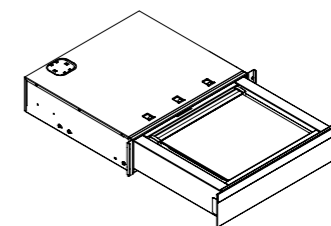

60 W x 55 D x 15 H



Household appliances are not subject to discounts

Gli elettrodomestici non sono soggetti a sconti

Les appareils ménagers ne font pas l'objet de remises

## STANDARD CONFIGURATION INCLUDED EQUIPMENT CONFIGURAZIONE STANDARD EQUIPAGGIAMENTO INCLUSO - ÉQUIPEMENT DE CONFIGURATION STANDARD INCLUS

- LED lamp  
Lampada a LED  
Lampe à LED

- Shelves  
Mensole  
Étagères

- Drawers with soft closing mechanism  
Cassetti con chiusura ammortizzata  
Tiroirs avec fermeture en douceur

- Induction hob + filtering aspirator  
CombiCookTop  
Piano cottura a induzione + aspiratore filtrante  
CombiCookTop  
Plaque à induction + aspirateur filtrant  
CombiCookTop

- Sink + Tap  
Lavello + Rubinetto  
Évier + Robinet

- Power socket + 2x USB  
Presa di corrente + 2x USB  
Prise de courant + 2x USB

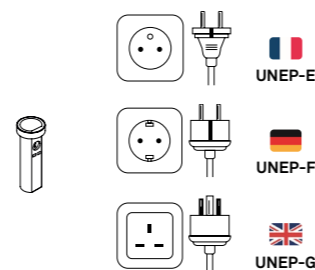
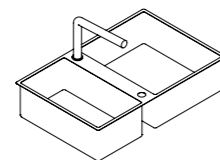
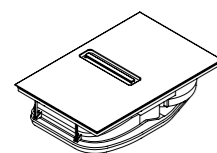

- Induction hob drawer  
Cassetto piano cottura  
Tiroir plaque à induction

- Sink drawer  
Cassetto lavello  
Tiroir d'évier

- Side drawer  
Cassetto laterale  
Tiroir latéral

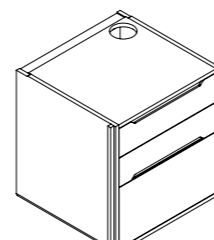
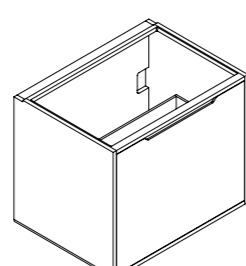
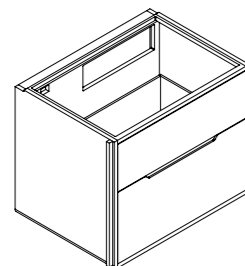

## WING KITCHEN

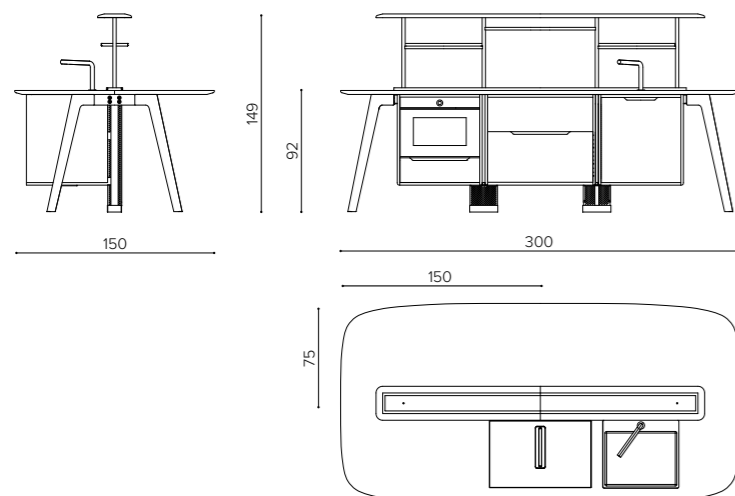

### WI 300K

#### Wing kitchen 300x150 standard configuration

Wing Kitchen 300x150 configurazione standard  
Wing Kitchen 300x150 configuration standard

## STANDARD CONFIGURATION INCLUDED EQUIPMENT

### CONFIGURAZIONE STANDARD EQUIPAGGIAMENTO INCLUSO - ÉQUIPEMENT DE CONFIGURATION STANDARD INCLUS

- LED lamp  
Lampada a LED  
Lampe à LED
- Shelves  
Mensole  
Étagères
- Drawers with soft closing mechanism  
Cassetti con chiusura ammortizzata  
Tiroirs avec fermeture en douceur
- Induction hob + filtering aspirator  
CombiCookTop  
Piano cottura a induzione + aspiratore filtrante  
CombiCookTop  
Plaque à induction + aspirateur filtrant  
CombiCookTop
- Sink + Tap  
Lavello + Rubinetto  
Évier + Robinet

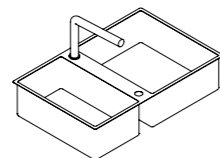
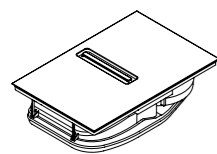

- Induction hob drawer  
Cassetto piano cottura  
Tiroir plaque à induction

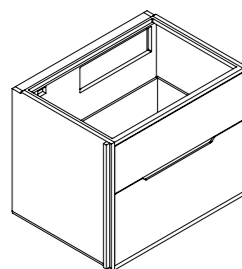

- Sink drawer  
Cassetto lavello  
Tiroir d'évier

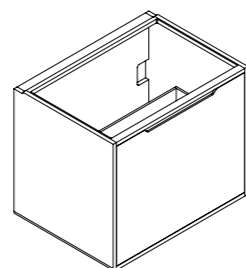

## OPTIONAL EQUIPMENT

### EQUIPAGGIAMENTO OPZIONALE - ÉQUIPEMENT OPTIONEL

#### WK

#### V-ZUG combined steam oven

Forno a vapore combinato V-ZUG  
Four mixte à vapeur V-ZUG

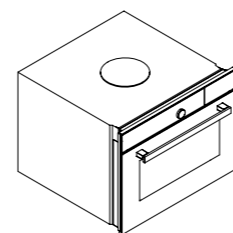

60 W x 60 D x 45 H

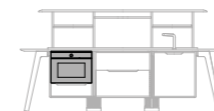

#### WK

#### vacuum drawer

cassetto sottovuoto  
tiroirs à vide

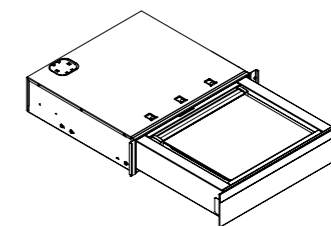

60 W x 55 D x 15 H



Household appliances are not subject to discounts

Gli elettrodomestici non sono soggetti a sconti

Les appareils ménagers ne font pas l'objet de remises

**CHOPPING BOARDS**  
TAGLIERI - PLANCHE À DÉCOUPER

**WK CH1512**  
chopping board  
tagliere  
planche à découper

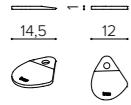

**WK CH1516**  
chopping board  
tagliere  
planche à découper

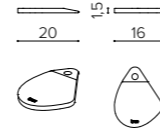

**WK CH3915**  
chopping board  
tagliere  
planche à découper

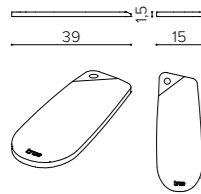

**WK CH5323**  
chopping board  
tagliere  
planche à découper

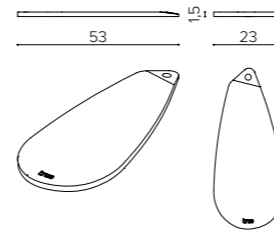

**WOOD**  
LEGNO - BOIS



The standard finishings are oakwood, american walnut or ashwood.  
Customized RAL colors are available upon request.

Le finiture standard sono rovere, noce americano o frassino.  
Colori RAL personalizzati sono disponibili su richiesta.

Les finitions standard sont le chêne, le noyer américain ou le frêne.  
Sur demande, d'autres essences de bois et couleurs spéciales sont disponibles en RA.

# OUTDOOR USE AND MAINTENANCE

USO E MANUTENZIONE PER L'OUTDOOR - UTILISATION ET MAINTENANCE POUR L'EXTÉRIUR



**STEEL**  
METALLO/MÉTAL

Steel is used in the manufacture of metal products. This material galvanised and powder-coated, is ideal for outdoor use. Regarding products intended for seaside locations we recommend cleaning on a quarterly basis, with a cloth using water or mild detergents. During the winter period we recommend storing the furniture in closed, dry rooms in order to prevent condensation. In fact, although our products are suitable for outdoor use, during colder months the products should be stored in a closed, dry place in order to prevent moisture and seasonal frosts from affecting the finish.

Nella realizzazione dei prodotti metallici viene impiegato l'acciaio, il quale in seguito al processo di zincatura e di verniciatura a polveri, risulta ideale per l'utilizzo outdoor. Durante il periodo invernale consigliamo di conservare gli arredi in luoghi chiusi ed asciutti per evitare la formazione di condensa. Per i prodotti destinati a località marittime consigliamo con cadenza trimestrale una pulizia con un panno utilizzando acqua o detersivi non aggressivi. Nonostante i nostri prodotti siano adatti all'ambiente esterno, durante il periodo invernale è consigliato il ricovero dei prodotti in un luogo chiuso ed asciutto. In modo da evitare che l'umidità unita alle gelate stagionali possa in qualche modo intaccare le finiture.

L'acier est la matière première utilisée dans la fabrication de ces produits métalliques qui, après un processus de galvanisation et un revêtement de finition par poudre, sont idéaux pour une utilisation en extérieur. Pour les produits destinés à être utilisés en bord de mer, nous recommandons un nettoyage trimestriel avec un chiffon utilisant de l'eau ou des détergents doux. Bien que nos produits soient adaptés à un usage extérieur, nous recommandons de les stocker dans un endroit fermé et sec pendant l'hiver; ceci afin d'éviter que l'humidité combinée aux gelées saisonnières n'affecte d'une manière ou d'une autre les finitions.

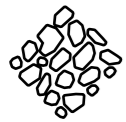

**STONE**  
PIETRA/PIERRE

The stone tops are made of Marble or Quarella and they are ideal for the outdoor environment. Use a soft cloth with just water for daily cleaning. Avoid the use of aggressive abrasive sponges or steel wool pads. The furnishings made of stone such as marble and Quarella, during the first week of use will undergo a slight dulling due to contact with external elements. This is a natural phenomenon which does not affect the quality of the material. When the furniture is placed in seaside locations or swimming pools, cleaning with fresh water on a quarterly basis is recommended in order to avoid water corrosion due to salt build-up or chlorosis. Although our products are suitable for outdoor use, during colder months the products should be stored in a closed, dry place in order to prevent moisture and seasonal frosts from affecting the finish.

Materiale composito autoportante adatto all'ambiente Outdoor. Utilizzare un panno morbido con sola acqua per la pulizia quotidiana. In caso di necessità utilizzare detersivi non aggressivi. Evitare l'impiego di spugne abrasive o pagliette in acciaio. Nel caso di collocamento degli arredi in località marittime o piscine, si consiglia una pulizia trimestrale utilizzando acqua dolce per evitare principi di corrosione dovuti ad accumuli salini o clorosi. Nonostante i nostri prodotti siano adatti all'ambiente esterno, durante il periodo invernale è consigliato il ricovero dei prodotti in un luogo chiuso ed asciutto. In modo da evitare che l'umidità unita alle gelate stagionali possa in qualche modo intaccare le finiture.

Les dessus en pierre sont en marbre ou en quarella, idéaux pour une utilisation en extérieur. Utilisez un chiffon doux avec de l'eau uniquement pour le nettoyage quotidien. Évitez d'utiliser des détergents agressifs, des éponges abrasives ou des tampons de laine d'acier. Les meubles en pierre tels que le marbre et la Quarella, pendant la première semaine, subissent un léger ternissement dû au contact avec les éléments extérieurs. Il s'agit d'un phénomène naturel, qui n'affecte pas la qualité du matériau. Si le meuble est placé dans des stations balnéaires ou des piscines, nous recommandons un nettoyage trimestriel à l'eau douce pour éviter la corrosion due à l'accumulation de sel ou à la chlorose. Bien que nos produits conviennent à une utilisation en extérieur, il est recommandé, pendant la période hivernale, de stocker les produits dans un endroit fermé et sec, afin d'éviter que l'humidité combinée aux gelées saisonnières n'affecte d'une manière ou d'une autre la finition.



**FABRICS**  
TESSUTI/TISSU

The fabrics used are naturally resistant to climatic elements, UV-resistant and anti-microbial. After heavy rainfall it is recommended to remove the cushions for quick drying and in order to prevent condensation. When the furniture is placed in seaside locations or swimming pools, cleaning with fresh water on a quarterly basis is recommended in order to avoid water corrosion due to salt build-up or chlorosis. Although our products are suitable for outdoor use, during colder months the products should be stored in a closed, dry place in order to prevent moisture and seasonal frosts from affecting the finish.

I tessuti impiegati sono naturalmente resistenti agli elementi climatici, resistenti ai raggi UV ed anti-microbici. A seguito di forti precipitazioni è consigliato rimuovere i cuscini per un'asciugatura rapida e prevenire la formazione di condensa. Nel caso di collocamento degli arredi in località marittime o piscine, si consiglia una pulizia trimestrale utilizzando acqua dolce per evitare principi di corrosione dovuti ad accumuli salini o clorosi. Nonostante i nostri prodotti siano adatti all'ambiente esterno, durante il periodo invernale è consigliato il ricovero dei prodotti in un luogo chiuso ed asciutto. In modo da evitare che l'umidità unita alle gelate stagionali possa in qualche modo intaccare le finiture.

Les tissus utilisés sont naturellement résistants aux éléments climatiques, résistants aux UV et antimicrobiens. Après de fortes pluies, il est toutefois conseillé de retirer les coussins pour un séchage rapide et pour éviter la formation de condensation. Si le mobilier est placé dans des stations balnéaires ou des piscines, nous recommandons un nettoyage trimestriel à l'eau douce pour éviter la corrosion due à l'accumulation de sel ou de chlore. Bien que nos produits soient adaptés à une utilisation en extérieur, il est recommandé de les stocker dans un endroit fermé et sec pendant la période hivernale, afin d'éviter que l'humidité combinée aux gelées saisonnières n'affecte d'une manière ou d'une autre les finitions.

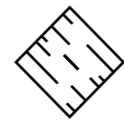

**HPL**  
HPL/HPLR

Self-supporting composite material suitable for outdoor environment. Use a soft cloth with water only for daily cleaning. If necessary, use non-aggressive detergents. Please avoid using abrasive sponges or steel wool pads. When the furniture is placed in seaside locations or swimming pools, cleaning with fresh water on a quarterly basis is recommended in order to avoid water corrosion due to salt build-up or chlorosis. Although our products are suitable for outdoor use, during colder months the products should be stored in a closed, dry place in order to prevent moisture and seasonal frosts from affecting the finish.

Materiale composito autoportante adatto all'ambiente Outdoor. Utilizzare un panno morbido con sola acqua per la pulizia quotidiana. In caso di necessità utilizzare detersivi non aggressivi. Evitare l'impiego di spugne abrasive o pagliette in acciaio. Nel caso di collocamento degli arredi in località marittime o piscine, si consiglia una pulizia trimestrale utilizzando acqua dolce per evitare principi di corrosione dovuti ad accumuli salini o clorosi. Nonostante i nostri prodotti siano adatti all'ambiente esterno, durante il periodo invernale è consigliato il ricovero dei prodotti in un luogo chiuso ed asciutto. In modo da evitare che l'umidità unita alle gelate stagionali possa in qualche modo intaccare le finiture.

Matériau composite autoportant adapté à un usage extérieur. Utilisez un chiffon doux avec de l'eau uniquement pour le nettoyage quotidien. Si nécessaire, utilisez des détergents non agressifs. Évitez d'utiliser des éponges abrasives ou des tampons de laine d'acier. Si le mobilier doit être installé dans des stations balnéaires ou des piscines, nous recommandons un nettoyage trimestriel à l'eau douce pour éviter la corrosion due au sel ou au chlore. Bien que nos produits conviennent à une utilisation en extérieur, il est recommandé, pendant la période hivernale, de stocker les produits dans un endroit fermé et sec, afin d'éviter que l'humidité combinée aux gelées saisonnières n'affecte d'une manière ou d'une autre les finitions.

# STANDARD STEEL RAL COLORS

COLORI RAL STANDARD PER ACCIAIO - COULEURS RAL STANDARD POUR L'ACIER

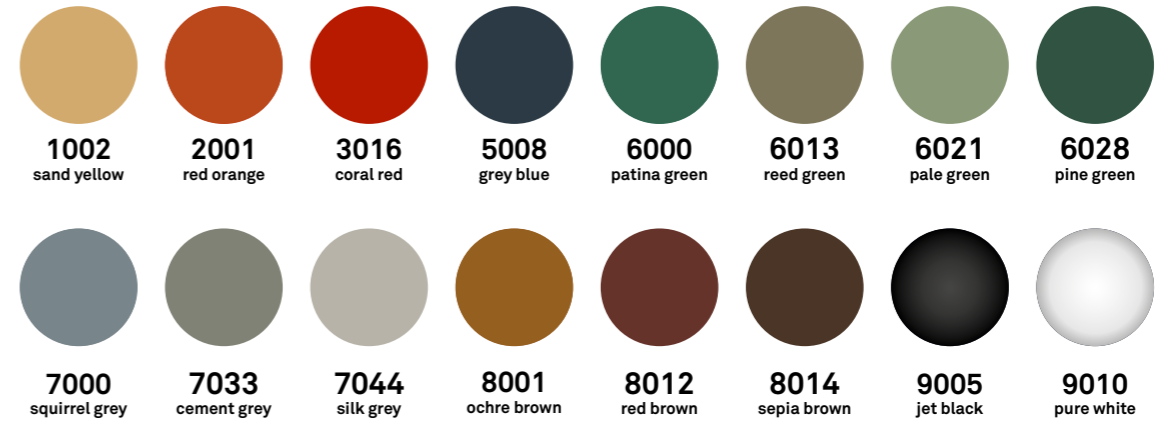

The standard finishings for the steel elements are the RAL shown. Customized RAL colors finishings are available upon request.

Le finiture standard degli elementi in acciaio sono i RAL mostrati. Su richiesta sono disponibili colorazioni customizzate su altre tinte RAL.

Les finitions standard des éléments en acier sont le RAL illustré. Des couleurs RAL personnalisées sont disponibles sur demande.



# MATERIAL FINISHES AND COLOR SWATCHES

FINITURE MATERIALI E CAMPIONI COLORI - FINITIONS ET ÉCHANTILLONS COULEURS

## DOWNLOAD

Click on the image above to download the material finishes and color swatches

Clicca sull'immagine per scaricare il pdf delle finiture dei materiali e dei campioni colori

Cliquez sur l'image associée pour télécharger les finitions et échantillons couleurs

