

# PATCH

Defne Koz & Marco Susani

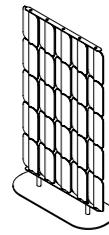

**STANDARD**  
STANDARD - STANDARD

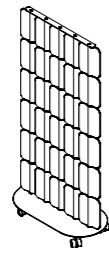

**CASTORS**  
RUOTE - ROUES

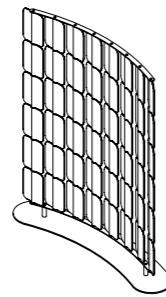

**CURVED**  
CURVO - INCURVÉ

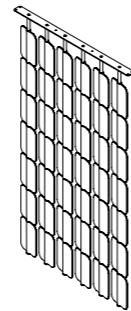

**HANGING**  
SOSPESO - PENDAISON

## COLORS AND MATERIALS

COLORI E MATERIALI - COULEURS ET MATÉRIAUX

### STEEL

ACCIAIO - ACIER



Click on the icon to see the standard RAL finishings for the steel bases on the dedicated page. Customized RAL colors finishings are available upon request.

Clicca sull'icona per vedere le finiture RAL standard delle basi in acciaio sulla pagina dedicata. Su richiesta sono disponibili colorazioni customizzate su altre tinte RAL.

Cliquez sur l'icône pour voir les finitions RAL standard des bases en acier sur la page dédiée. Des couleurs RAL personnalisées sont disponibles sur demande.

### FABRIC PANELS

PANNELLI IN TESSUTO - PANNEAUX EN TISSU

The Patch panels are available in up to 2 colors of your choice from the polyester Laser N fabric collection.

I pannelli patch sono disponibili in tessuto o in legno un massimo di 2 colori a scelta della collezione di tessuti in poliester Laser N.

Les panneaux patch sont disponibles en un maximum de 2 couleurs au choix de la collection de tissus polyester Laser N.

### WOODEN PANELS

PANNELLI IN LEGNO - PANNEAUX EN BOIS

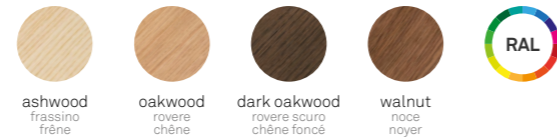

Beech plywood panels available in veneered ashwood, oakwood, dark oakwood or walnut. Customized RAL colors are available upon request.

Pannelli in multistrati faggio disponibile in finitura impiallacciata frassino, rovere, rovere scuro o noce. Colori RAL personalizzati sono disponibili su richiesta.

Panneaux en contreplaqué de hêtre disponible en frêne plaqué, chêne, chêne foncé ou noyer. Des couleurs RAL personnalisées sont disponibles sur demande.

## TECHNICAL FEATURES

SPECIFICHE TECNICHE - SPÉCIFICATIONS TECHNIQUES

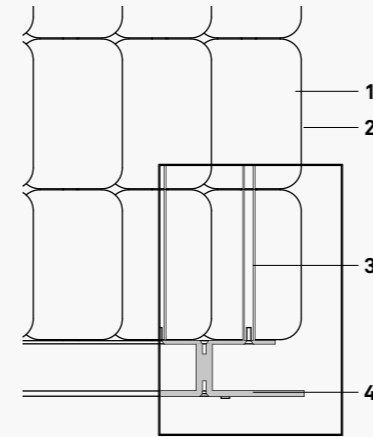

**STANDARD**  
STANDARD - STANDARD

**CURVED**  
CURVO - INCURVÉ

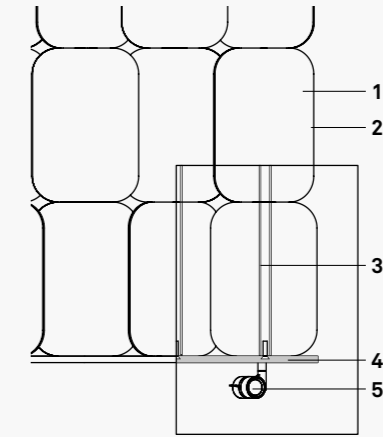

**CASTORS**  
RUOTE - ROUES

1. Polyester fiber or wooden panel  
Pannello in fibra di poliestere o in legno  
Panneau en fibre de polyester ou en bois
2. Fabric upholstery  
Rivestimento in tessuto  
Revêtement en tissu
3. Steel tube  
Tubo in acciaio  
Tube en acier
4. Steel plate base  
Piastra in acciaio  
Plaque d'acier
5. Aluminium and rubber castors  
Ruote in alluminio e gomma  
Roues en aluminium et en caoutchouc

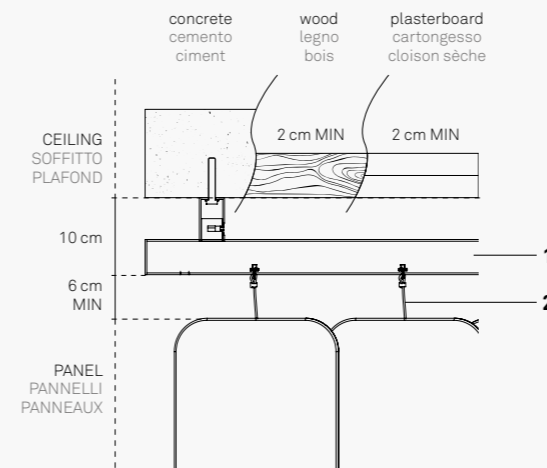

**HANGING**  
SOSPESO - PENDAISON

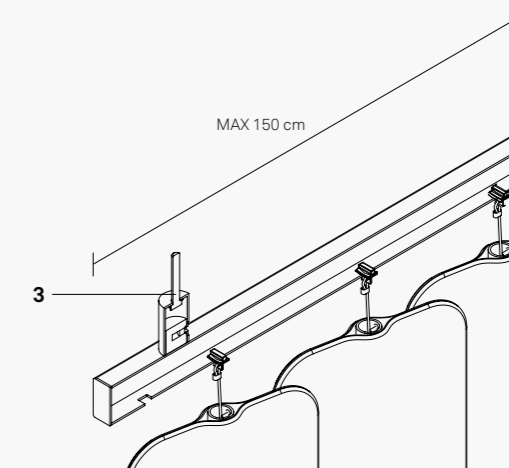

1. Steel structure  
Struttura in acciaio  
Structure en acier
2. Steel cable  
Cavo in acciaio  
Câble en acier
3. Steel anchor  
Tasseo in acciaio  
Tasseau en acier

The single panel is composed by a multilayer sheet of polyester and textile installed on a steel tube. Steel plate base for the free-standing version, metal rail for the ceiling hanging version. Suspended version suitable for different types of ceilings, for tightness and weights consult an installer's assessment. Minimum footprint of 16cm for beam and anchoring system.

Il modulo è composto da un cuscinetto di fibra di poliestere termoformato con due strati di tessuto, installato su un tubo d'acciaio. Base in lamiera d'acciaio per la versione free-standing, guida metallica per la versione sospesa a soffitto. Versione sospesa adatta a soffitti di diversa natura, per tenuta e pesi consultare una valutazione dell'installatore. Ingombro minimo di 16cm per la trave e il sistema di ancoraggio.

Le panneau simple est composé d'une feuille multicouche de polyester et de textile installée sur un tube d'acier. Socle en tôle d'acier pour la version autoportante, rail métallique pour la version suspendue au plafond. Version suspendue adaptée à différents types de plafonds, pour l'étanchéité et le poids, veuillez consulter un installateur. Dimension minimale de 16cm pour la poutre et le système d'ancrage.

**PA 1218**  
acoustic panel  
pannello acustico  
séparateur acoustique

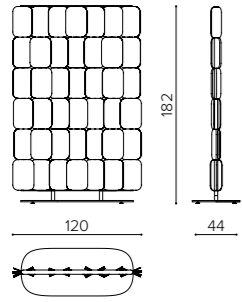

kg 40 mc 0,96

**PA 1218 MIX**  
acoustic panel  
pannello acustico  
séparateur acoustique

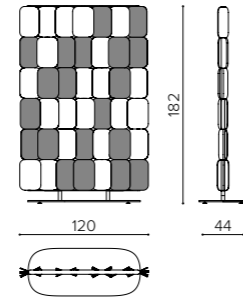

kg 40 mc 0,96

**PA 1215**  
acoustic panel  
pannello acustico  
séparateur acoustique

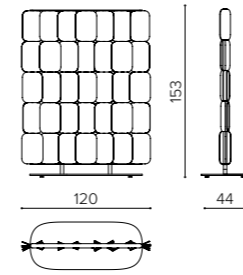

kg 35 mc 0,8

**PA 1215 MIX**  
acoustic panel  
pannello acustico  
séparateur acoustique

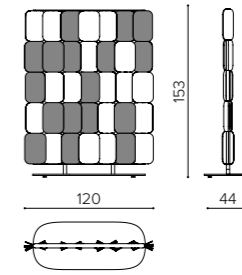

kg 35 mc 0,8

**PA 0818**  
acoustic panel  
pannello acustico  
séparateur acoustique

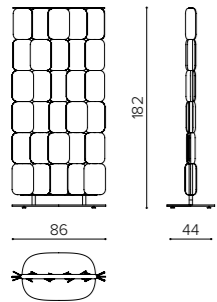

kg 30 mc 0,7

**PA 0818 MIX**  
acoustic panel  
pannello acustico  
séparateur acoustique

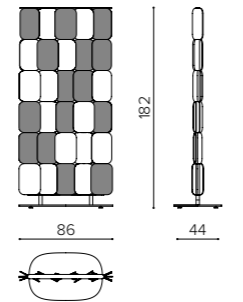

kg 30 mc 0,7

**PA 0815**  
acoustic panel  
pannello acustico  
séparateur acoustique

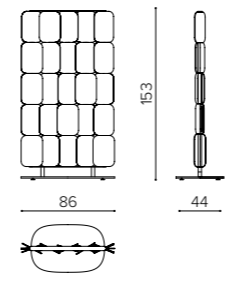

kg 27 mc 0,6

**PA 0815 MIX**  
acoustic panel  
pannello acustico  
séparateur acoustique

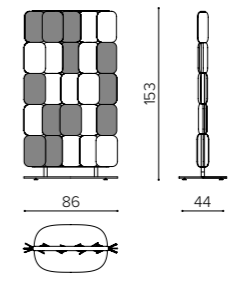

kg 27 mc 0,6

**PA 1518C**  
curved acoustic panel  
pannello acustico curvo  
séparateur acoustique courbé

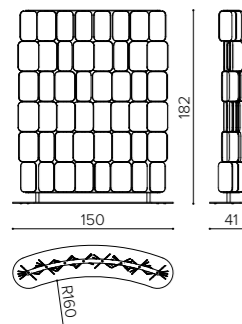

kg 50 mc 0,7

**PA 1518C MIX**  
curved acoustic panel  
pannello acustico curvo  
séparateur acoustique courbé

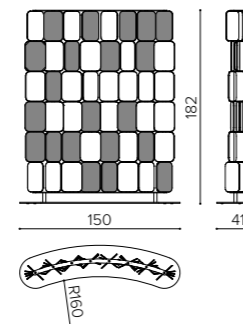

kg 50 mc 0,7

**PA 1218R**  
acoustic panel with castors  
pannello acustico con ruote  
séparateur acoustique avec roues

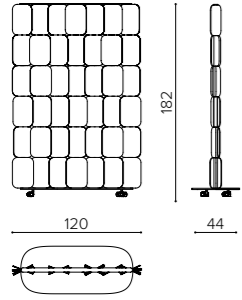

kg 40 mc 0,96

**PA 1218R MIX**  
acoustic panel with castors  
pannello acustico con ruote  
séparateur acoustique avec roues

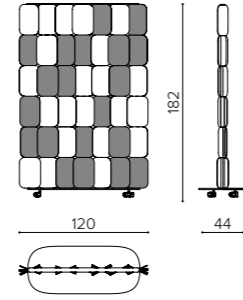

kg 40 mc 0,96

**PA 1215R**  
acoustic panel with castors  
pannello acustico con ruote  
séparateur acoustique avec roues

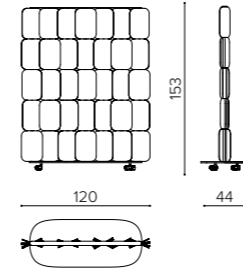

kg 35 mc 0,8

**PA 1215R MIX**  
acoustic panel with castors  
pannello acustico con ruote  
séparateur acoustique avec roues

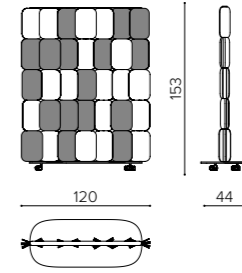

kg 35 mc 0,8

**PA 0818R**  
acoustic panel with castors  
pannello acustico con ruote  
séparateur acoustique avec roues

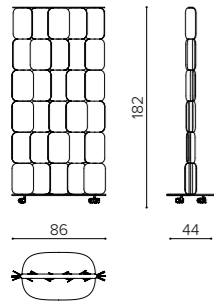

kg 30 mc 0,7

**PA 0818R MIX**  
acoustic panel with castors  
pannello acustico con ruote  
séparateur acoustique avec roues

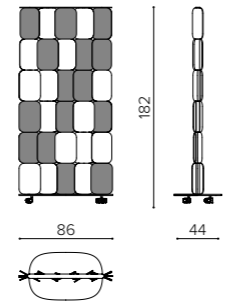

kg 30 mc 0,7

**PA 0815R**  
acoustic panel with castors  
pannello acustico con ruote  
séparateur acoustique avec roues

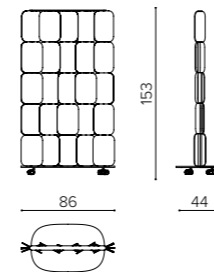

kg 27 mc 0,6

**PA 0815R MIX**  
acoustic panel with castors  
pannello acustico con ruote  
séparateur acoustique avec roues

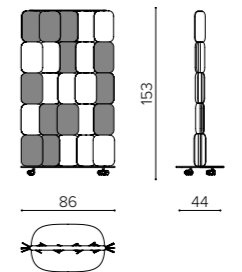

kg 27 mc 0,6

**PA H006****acoustic panel module for ceilings, beam MAX length 150**

pannello acustico per soffitti, trave lunghezza MAX 150 cm  
module de panneaux acoustiques pour plafonds, longueur MAX de la poutre 150 cm

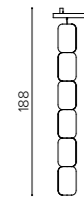

✚ mc 0,02

**PA H007****acoustic panel module for ceilings, beam MAX length 150**

pannello acustico per soffitti, trave lunghezza MAX 150 cm  
module de panneaux acoustiques pour plafonds, longueur MAX de la poutre 150 cm



✚ mc 0,02

**PA H008****acoustic panel module for ceilings between 250/280cm**

pannello acustico per soffitti tra 250 e 280cm  
module de panneaux acoustiques pour plafonds entre 250/280cm

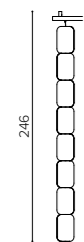

✚ mc 0,02

**PA H009****acoustic panel module for ceilings between 280/300cm**

pannello acustico per soffitti tra 280 e 300cm  
module de panneaux acoustiques pour plafonds entre 280/300cm



✚ mc 0,02

**PA H010****acoustic panel module for ceilings between 310/330cm**

pannello acustico per soffitti tra 310 e 330cm  
module de panneaux acoustiques pour plafonds entre 310/330cm

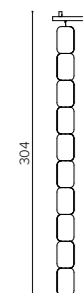

✚ mc 0,02

# OUTDOOR USE AND MAINTENANCE

USO E MANUTENZIONE PER L'OUTDOOR - UTILISATION ET MAINTENANCE POUR L'EXTÉRIUR



**STEEL**  
METALLO/MÉTAL

Steel is used in the manufacture of metal products. This material galvanised and powder-coated, is ideal for outdoor use. Regarding products intended for seaside locations we recommend cleaning on a quarterly basis, with a cloth using water or mild detergents. During the winter period we recommend storing the furniture in closed, dry rooms in order to prevent condensation. In fact, although our products are suitable for outdoor use, during colder months the products should be stored in a closed, dry place in order to prevent moisture and seasonal frosts from affecting the finish.

Nella realizzazione dei prodotti metallici viene impiegato l'acciaio, il quale in seguito al processo di zincatura e di verniciatura a polveri, risulta ideale per l'utilizzo outdoor. Durante il periodo invernale consigliamo di conservare gli arredi in luoghi chiusi ed asciutti per evitare la formazione di condensa. Per i prodotti destinati a località marittime consigliamo con cadenza trimestrale una pulizia con un panno utilizzando acqua o detersivi non aggressivi. Nonostante i nostri prodotti siano adatti all'ambiente esterno, durante il periodo invernale è consigliato il ricovero dei prodotti in un luogo chiuso ed asciutto. In modo da evitare che l'umidità unita alle gelate stagionali possa in qualche modo intaccare le finiture.

L'acier est la matière première utilisée dans la fabrication de ces produits métalliques qui, après un processus de galvanisation et un revêtement de finition par poudre, sont idéaux pour une utilisation en extérieur. Pour les produits destinés à être utilisés en bord de mer, nous recommandons un nettoyage trimestriel avec un chiffon utilisant de l'eau ou des détergents doux. Bien que nos produits soient adaptés à un usage extérieur, nous recommandons de les stocker dans un endroit fermé et sec pendant l'hiver; ceci afin d'éviter que l'humidité combinée aux gelées saisonnières n'affecte d'une manière ou d'une autre les finitions.



**STONE**  
PIETRA/PIERRE

The stone tops are made of Marble or Quarella and they are ideal for the outdoor environment. Use a soft cloth with just water for daily cleaning. Avoid the use of aggressive abrasive sponges or steel wool pads. The furnishings made of stone such as marble and Quarella, during the first week of use will undergo a slight dulling due to contact with external elements. This is a natural phenomenon which does not affect the quality of the material. When the furniture is placed in seaside locations or swimming pools, cleaning with fresh water on a quarterly basis is recommended in order to avoid water corrosion due to salt build-up or chlorosis. Although our products are suitable for outdoor use, during colder months the products should be stored in a closed, dry place in order to prevent moisture and seasonal frosts from affecting the finish.

Materiale composito autoportante adatto all'ambiente Outdoor. Utilizzare un panno morbido con sola acqua per la pulizia quotidiana. In caso di necessità utilizzare detersivi non aggressivi. Evitare l'impiego di spugne abrasive o pagliette in acciaio. Nel caso di collocamento degli arredi in località marittime o piscine, si consiglia una pulizia trimestrale utilizzando acqua dolce per evitare principi di corrosione dovuti ad accumuli salini o clorosi. Nonostante i nostri prodotti siano adatti all'ambiente esterno, durante il periodo invernale è consigliato il ricovero dei prodotti in un luogo chiuso ed asciutto. In modo da evitare che l'umidità unita alle gelate stagionali possa in qualche modo intaccare le finiture.

Les dessus en pierre sont en marbre ou en quarella, idéaux pour une utilisation en extérieur. Utilisez un chiffon doux avec de l'eau uniquement pour le nettoyage quotidien. Évitez d'utiliser des détergents agressifs, des éponges abrasives ou des tampons de laine d'acier. Les meubles en pierre tels que le marbre et la Quarella, pendant la première semaine, subissent un léger ternissement dû au contact avec les éléments extérieurs. Il s'agit d'un phénomène naturel, qui n'affecte pas la qualité du matériau. Si le meuble est placé dans des stations balnéaires ou des piscines, nous recommandons un nettoyage trimestriel à l'eau douce pour éviter la corrosion due à l'accumulation de sel ou à la chlorose. Bien que nos produits conviennent à une utilisation en extérieur, il est recommandé, pendant la période hivernale, de stocker les produits dans un endroit fermé et sec, afin d'éviter que l'humidité combinée aux gelées saisonnières n'affecte d'une manière ou d'une autre la finition.



**FABRICS**  
TESSUTI/TISSU

The fabrics used are naturally resistant to climatic elements, UV-resistant and anti-microbial. After heavy rainfall it is recommended to remove the cushions for quick drying and in order to prevent condensation. When the furniture is placed in seaside locations or swimming pools, cleaning with fresh water on a quarterly basis is recommended in order to avoid water corrosion due to salt build-up or chlorosis. Although our products are suitable for outdoor use, during colder months the products should be stored in a closed, dry place in order to prevent moisture and seasonal frosts from affecting the finish.

I tessuti impiegati sono naturalmente resistenti agli elementi climatici, resistenti ai raggi UV ed anti-microbici. A seguito di forti precipitazioni è consigliato rimuovere i cuscini per un'asciugatura rapida e prevenire la formazione di condensa. Nel caso di collocamento degli arredi in località marittime o piscine, si consiglia una pulizia trimestrale utilizzando acqua dolce per evitare principi di corrosione dovuti ad accumuli salini o clorosi. Nonostante i nostri prodotti siano adatti all'ambiente esterno, durante il periodo invernale è consigliato il ricovero dei prodotti in un luogo chiuso ed asciutto. In modo da evitare che l'umidità unita alle gelate stagionali possa in qualche modo intaccare le finiture.

Les tissus utilisés sont naturellement résistants aux éléments climatiques, résistants aux UV et antimicrobiens. Après de fortes pluies, il est toutefois conseillé de retirer les coussins pour un séchage rapide et pour éviter la formation de condensation. Si le mobilier est placé dans des stations balnéaires ou des piscines, nous recommandons un nettoyage trimestriel à l'eau douce pour éviter la corrosion due à l'accumulation de sel ou de chlore. Bien que nos produits soient adaptés à une utilisation en extérieur, il est recommandé de les stocker dans un endroit fermé et sec pendant la période hivernale, afin d'éviter que l'humidité combinée aux gelées saisonnières n'affecte d'une manière ou d'une autre les finitions.

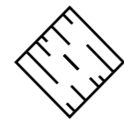

**HPL**  
HPL/HPLR

Self-supporting composite material suitable for outdoor environment. Use a soft cloth with water only for daily cleaning. If necessary, use non-aggressive detergents. Please avoid using abrasive sponges or steel wool pads. When the furniture is placed in seaside locations or swimming pools, cleaning with fresh water on a quarterly basis is recommended in order to avoid water corrosion due to salt build-up or chlorosis. Although our products are suitable for outdoor use, during colder months the products should be stored in a closed, dry place in order to prevent moisture and seasonal frosts from affecting the finish.

Materiale composito autoportante adatto all'ambiente Outdoor. Utilizzare un panno morbido con sola acqua per la pulizia quotidiana. In caso di necessità utilizzare detersivi non aggressivi. Evitare l'impiego di spugne abrasive o pagliette in acciaio. Nel caso di collocamento degli arredi in località marittime o piscine, si consiglia una pulizia trimestrale utilizzando acqua dolce per evitare principi di corrosione dovuti ad accumuli salini o clorosi. Nonostante i nostri prodotti siano adatti all'ambiente esterno, durante il periodo invernale è consigliato il ricovero dei prodotti in un luogo chiuso ed asciutto. In modo da evitare che l'umidità unita alle gelate stagionali possa in qualche modo intaccare le finiture.

Matériau composite autoportant adapté à un usage extérieur. Utilisez un chiffon doux avec de l'eau uniquement pour le nettoyage quotidien. Si nécessaire, utilisez des détergents non agressifs. Évitez d'utiliser des éponges abrasives ou des tampons de laine d'acier. Si le mobilier doit être installé dans des stations balnéaires ou des piscines, nous recommandons un nettoyage trimestriel à l'eau douce pour éviter la corrosion due au sel ou au chlore. Bien que nos produits conviennent à une utilisation en extérieur, il est recommandé, pendant la période hivernale, de stocker les produits dans un endroit fermé et sec, afin d'éviter que l'humidité combinée aux gelées saisonnières n'affecte d'une manière ou d'une autre les finitions.

# STANDARD STEEL RAL COLORS

COLORI RAL STANDARD PER ACCIAIO - COULEURS RAL STANDARD POUR L'ACIER

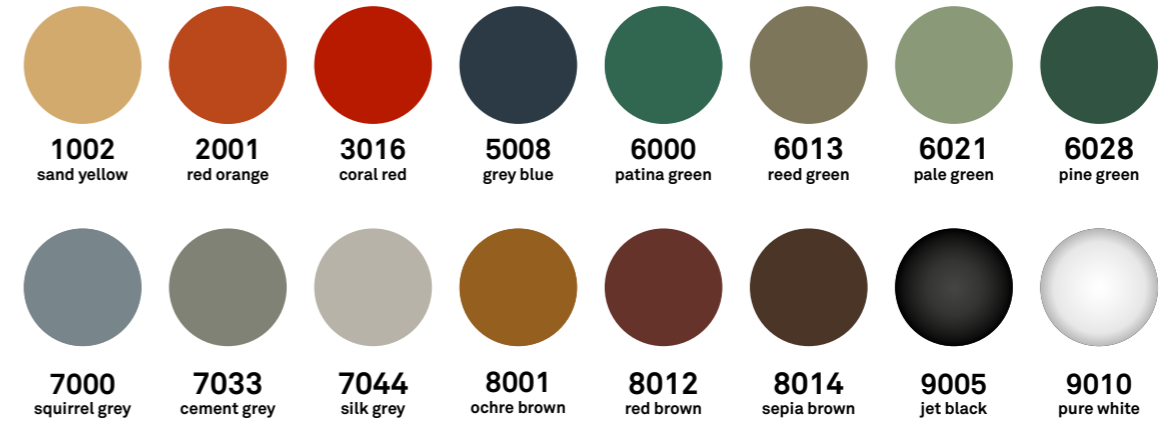

The standard finishings for the steel elements are the RAL shown. Customized RAL colors finishings are available upon request.

Le finiture standard degli elementi in acciaio sono i RAL mostrati. Su richiesta sono disponibili colorazioni customizzate su altre tinte RAL.

Les finitions standard des éléments en acier sont le RAL illustré. Des couleurs RAL personnalisées sont disponibles sur demande.



# MATERIAL FINISHES AND COLOR SWATCHES

FINITURE MATERIALI E CAMPIONI COLORI - FINITIONS ET ÉCHANTILLONS COULEURS

## DOWNLOAD

Click on the image above to download the material finishes and color swatches

Clicca sull'immagine per scaricare il pdf delle finiture dei materiali e dei campioni colori

Cliquez sur l'image associée pour télécharger les finitions et échantillons couleurs



FIDIVI\*

LASER N

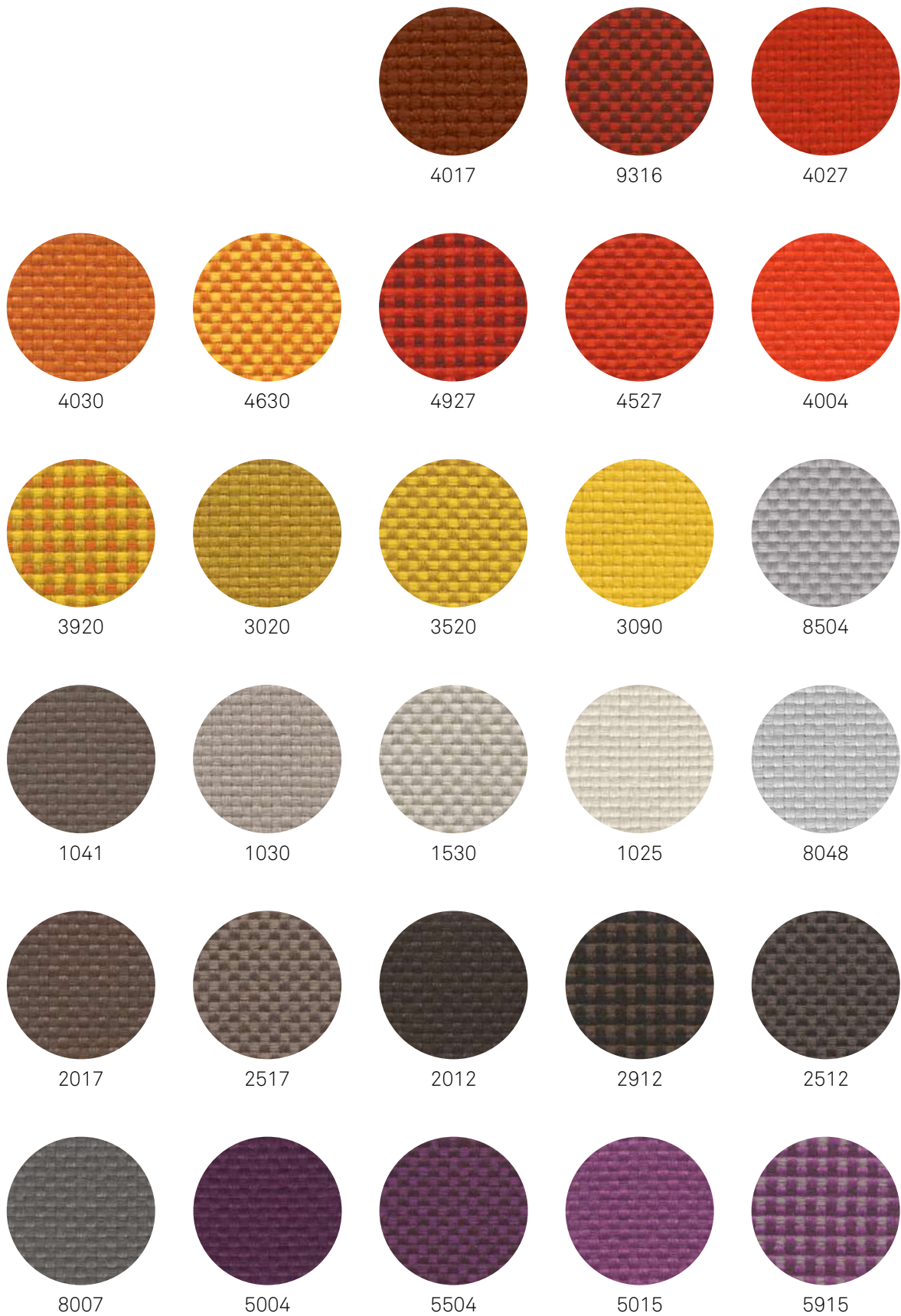

true



FIDIVI\*

LASER N

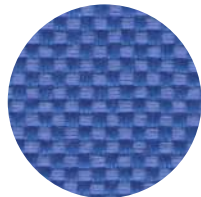

9261

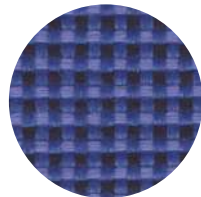

6971

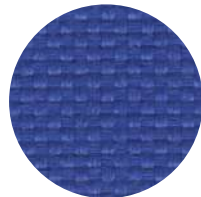

6071

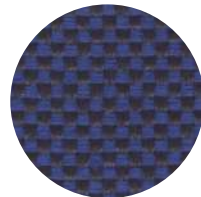

6517



6017

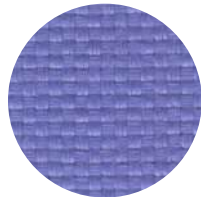

6070

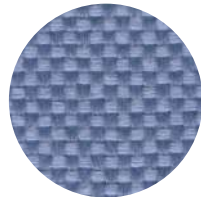

6543

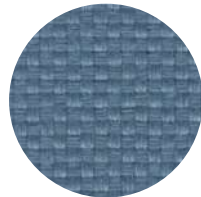

6043

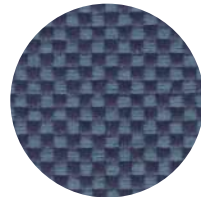

6579

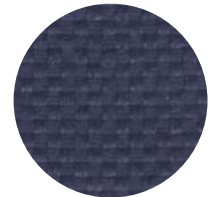

6079

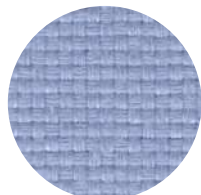

6056

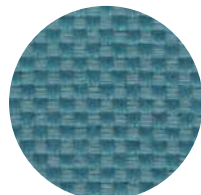

6537

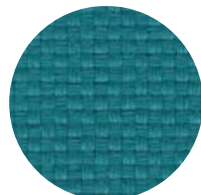

6037

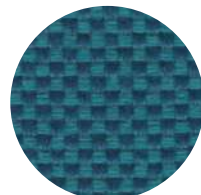

6531

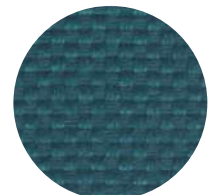

6031

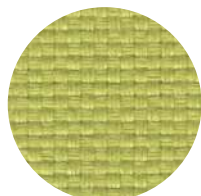

7041

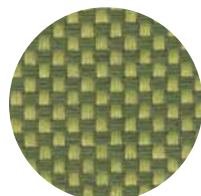

7553

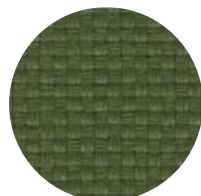

7020

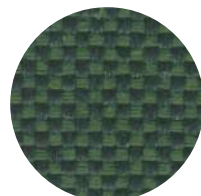

7536

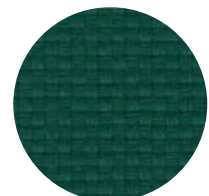

7036

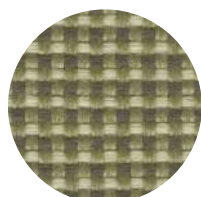

7934

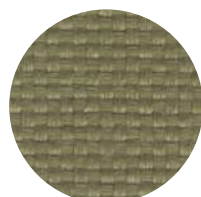

7034

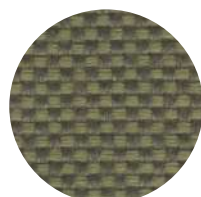

7520

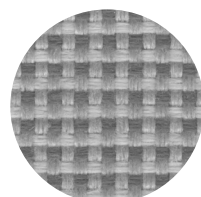

8904

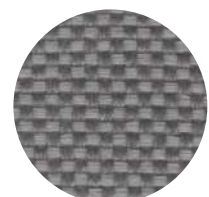

8532

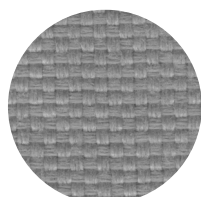

8004

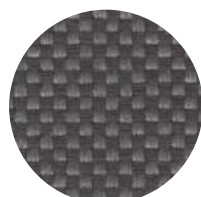

9301

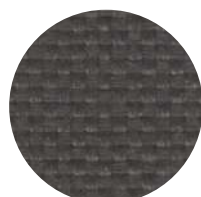

8010

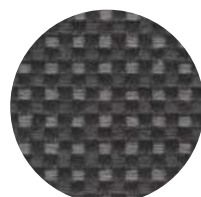

9338



8033

true

